

Préhenseur ROB240

- 2 faces actives
- fixation universelle
- pôles amovibles adaptables aux pièces

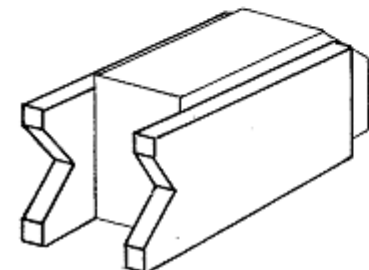

— Pour cylindre . Axe horizontal

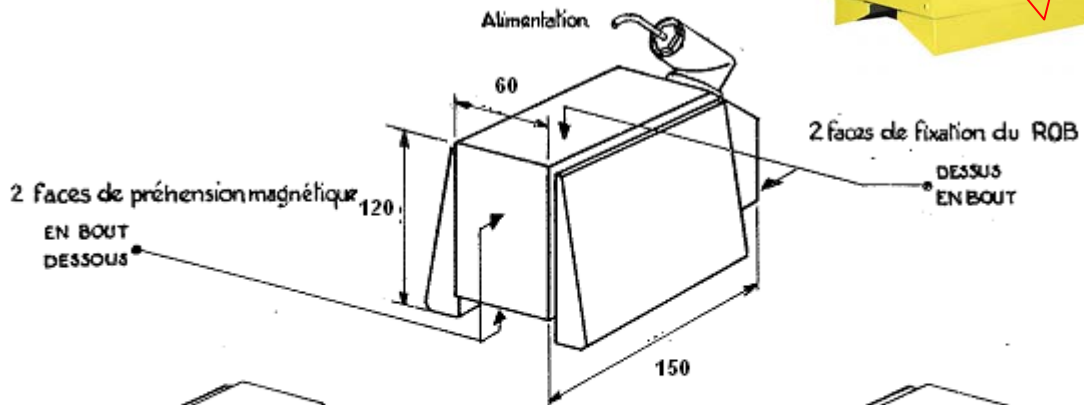
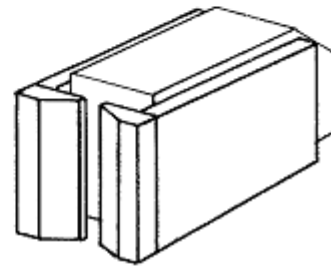

— Pour cylindre . Axe vertical

- . sécurité totale
- . CMU 240 Kg
- . poids 7 Kg*

*sans les pôles

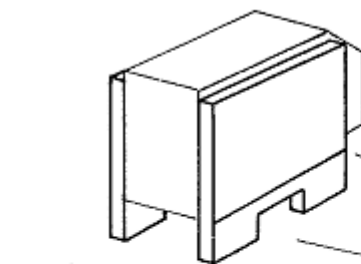

— Dégagement pour bossage

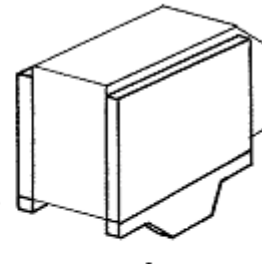

— Pour prise en fond de U

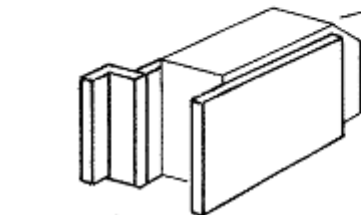

— Prise élargie décentrée

Pôles amovibles
adaptables
aux géométries des pièces

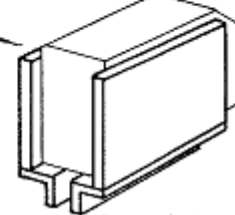

— Prise étroite centrée